

Double Hung, Hidden Balance

- Section Details : Operating/Stationary, 5 1/4 Jamb, Traditional Sash
- Section Details : Operating/Stationary, 6 9/16 Jamb, Traditional Sash
- Section Details : Operating/Stationary, 4 9/16 Jamb, Traditional Sash
- Section Details : Insert, 4 3/8 Jamb, Traditional Sash
- Section Details : Sash Profiles & SDL Options
- Section Details : Mull Sections
- Section Details : Sill Options
- Section Details : Exterior Trim Options
- Section Details : Nail Fin Options

Double Hung, Hidden Balance

Section Details : Block & Tackle, 5 1/4" Jamb

Traditional Sash
1/2" Long Bead Detail

SCALE: 3" = 1'-0"

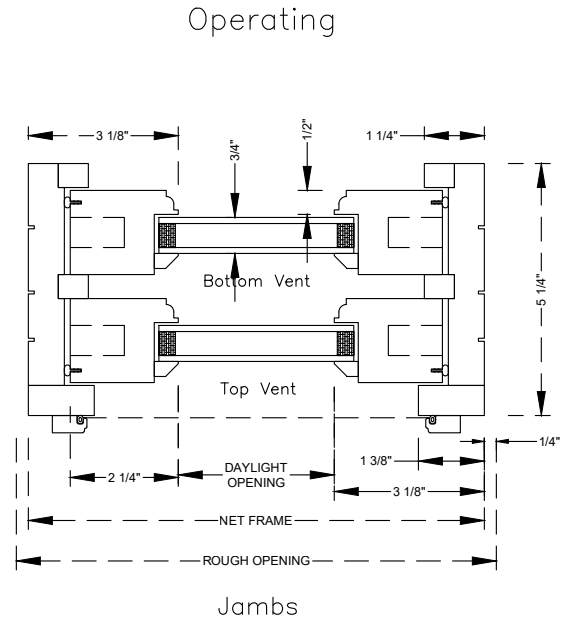
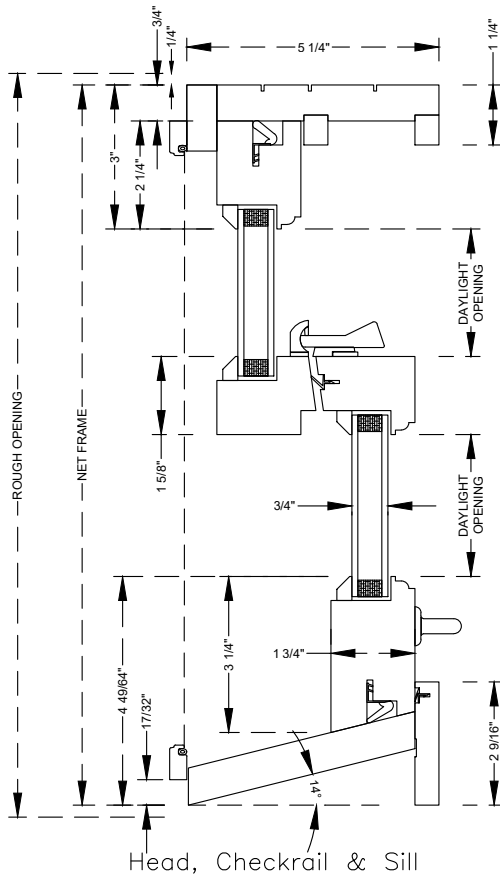

Stationary

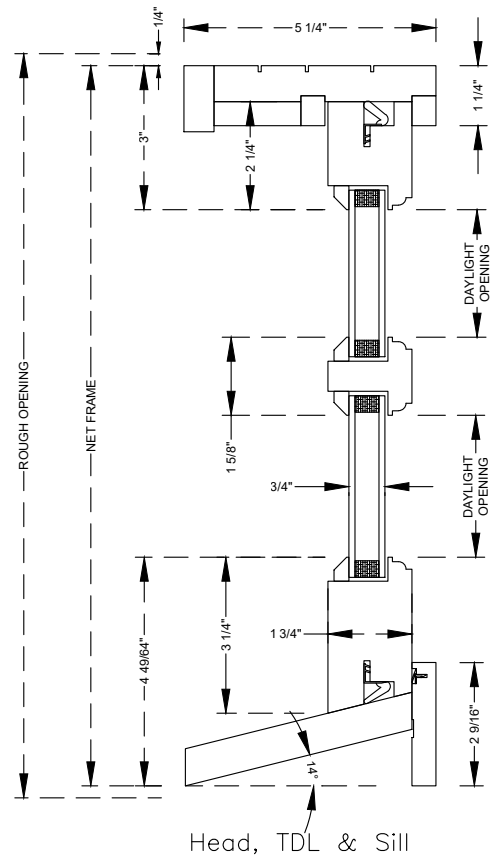
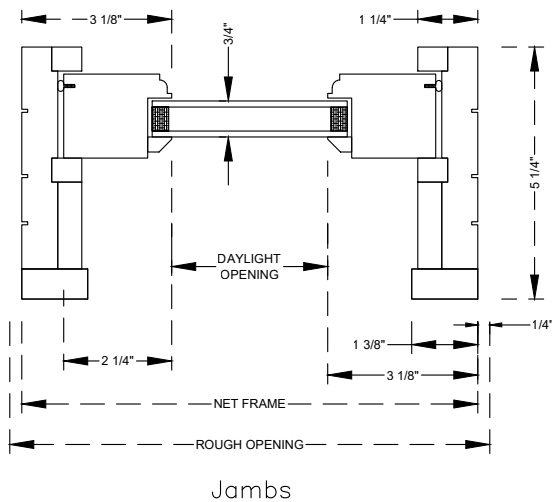

Double Hung, Hidden Balance

Section Details : Block & Tackle, 6 9/16" Jamb

Traditional Sash
1/2" Long Bead Detail

SCALE: 3" = 1'-0"

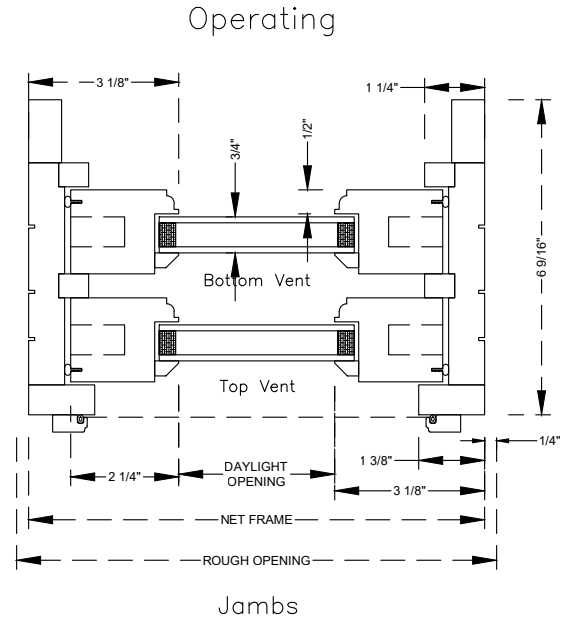
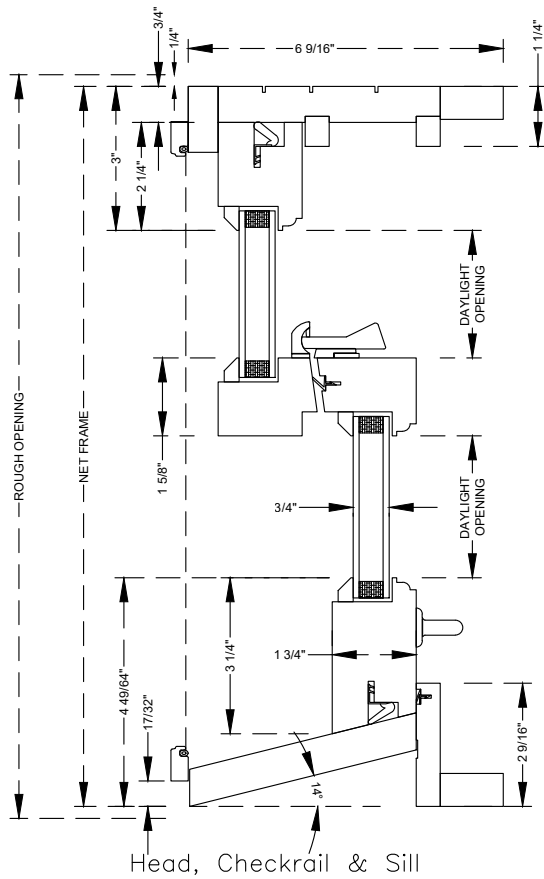

Stationary

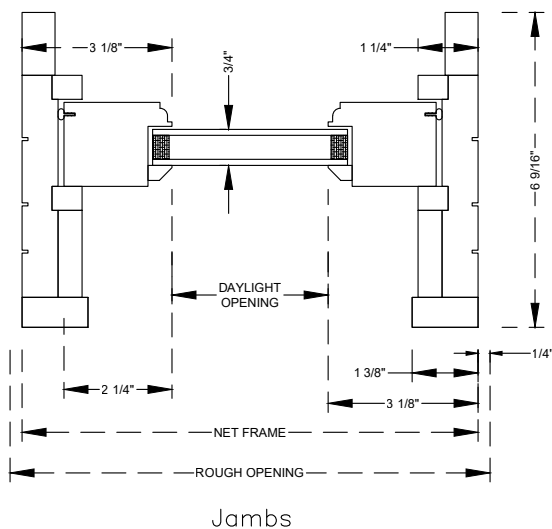

Jamb

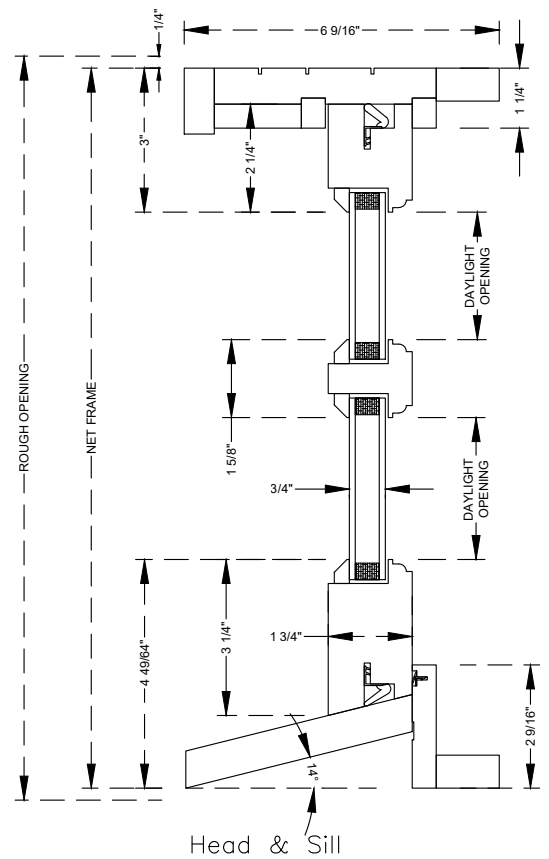

Double Hung, Hidden Balance

Section Details : Block & Tackle, 4 9/16" Jamb

Traditional Sash
3/8" Long Bead Detail

SCALE: 3" = 1'-0"

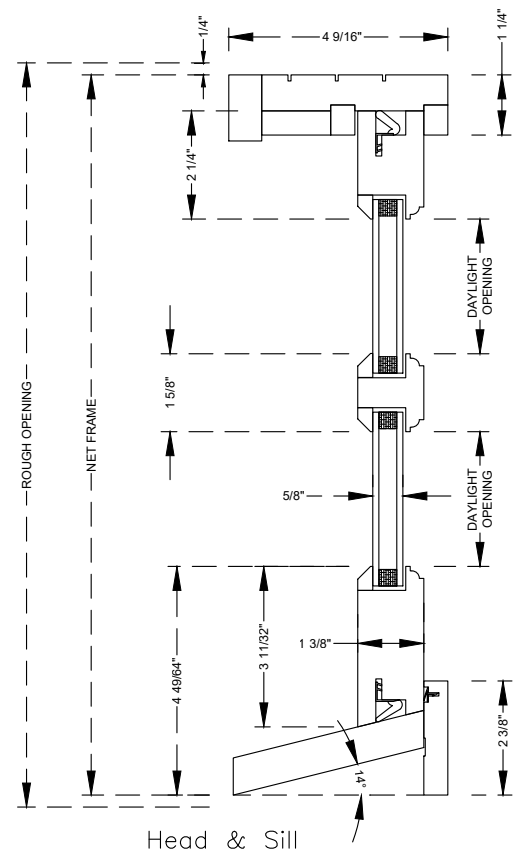
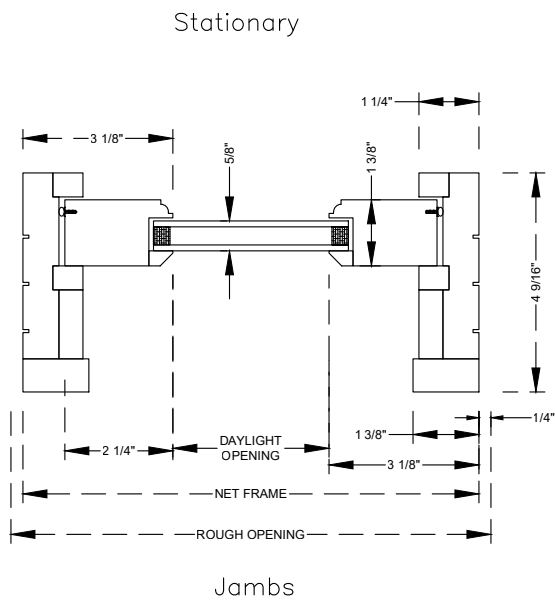
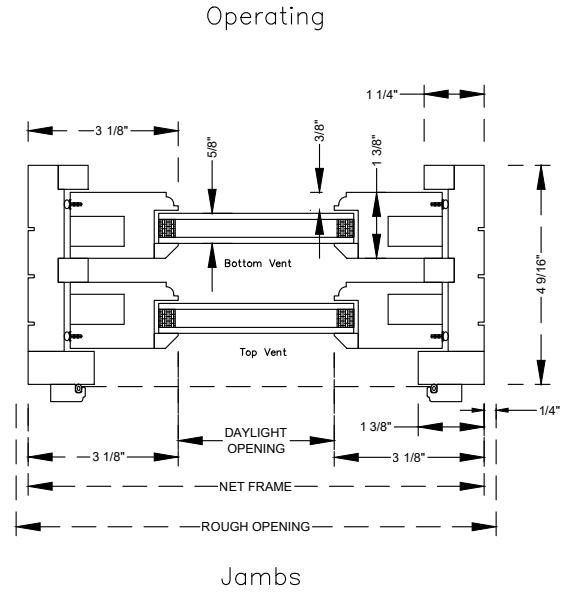
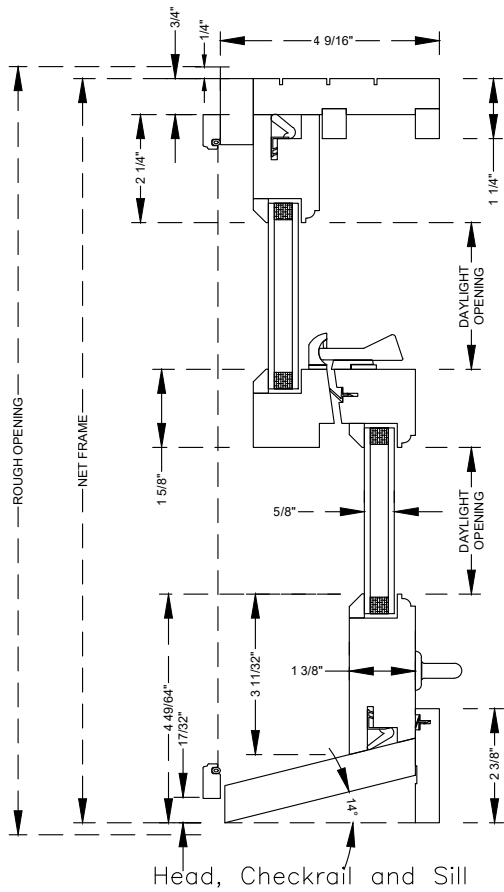

Double Hung, Hidden Balance



Section Details : Block & Tackle Insert, 4 3/8" Jamb

SCALE: 3" = 1'-0"

Traditional Sash
1/2" Long Bead Detail

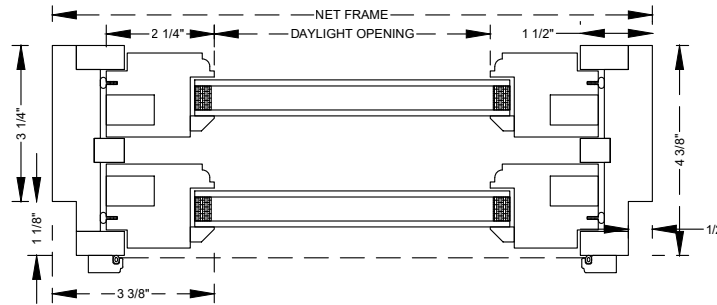

Jamb

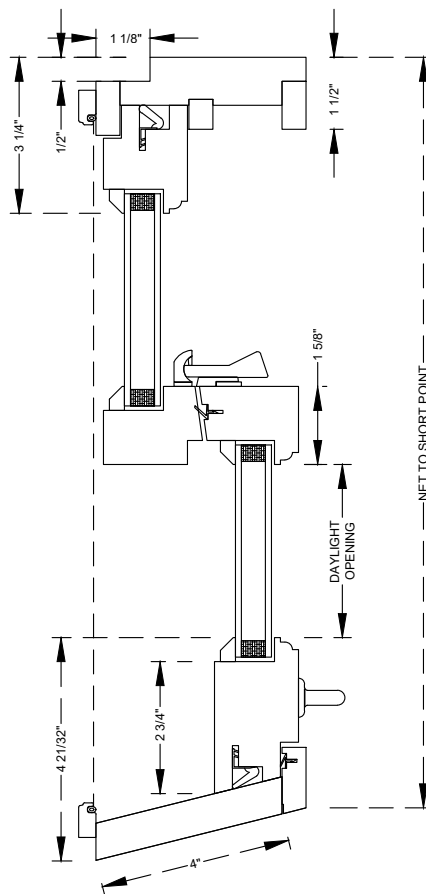

Adjustable sill angle from 5 - 14 degrees

Head & Sill

Double Hung, Hidden Balance

Section Details : Sash Profiles & SDL Options

SCALE: 3" = 1'-0"

Sash Profiles & SDL Options

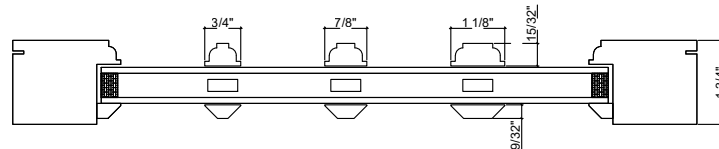

1/2" Long Bead Interior/Bevel Bead Exterior

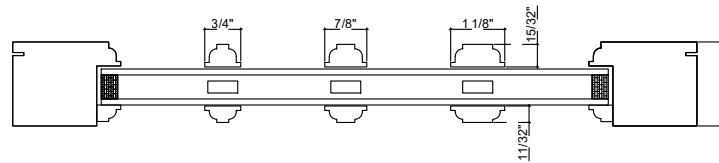

1/2" Long Bead Interior/Long Bead Exterior

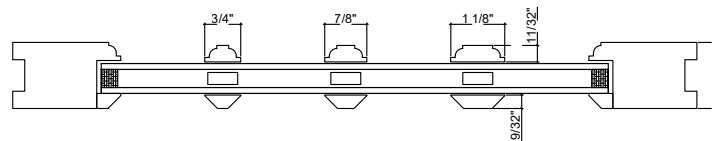

3/8" Long Bead Interior/Bevel Bead Exterior *

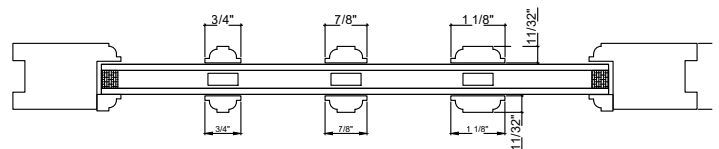

3/8" Long Bead Interior/Long Bead Exterior *

*With 1-3/8 Sash, 4-9/16" Jamb Only

Double Hung, Hidden Balance

Section Details : Mull Sections

SCALE: 3" = 1'-0"

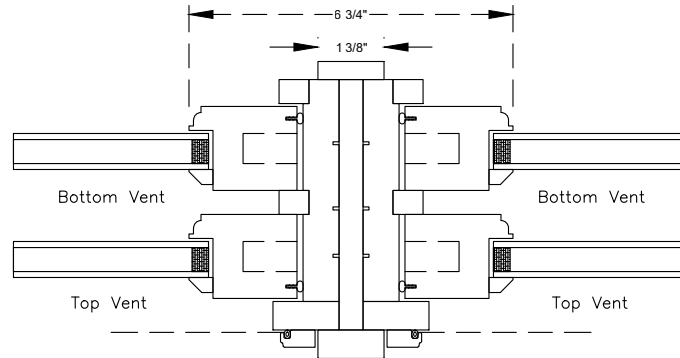

Standard Stack Mull

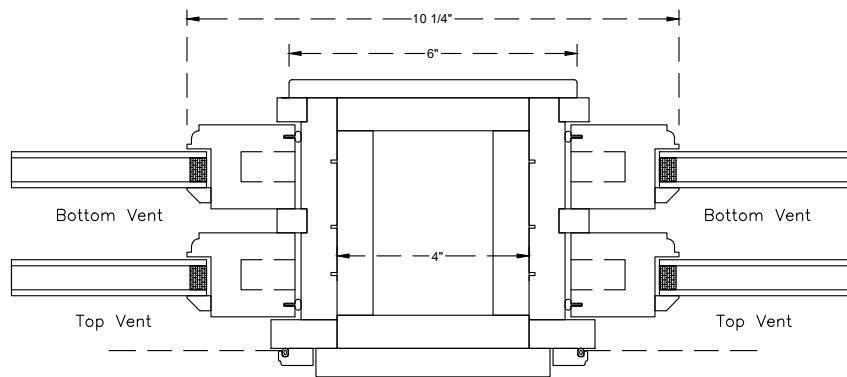

4" Spread Mull

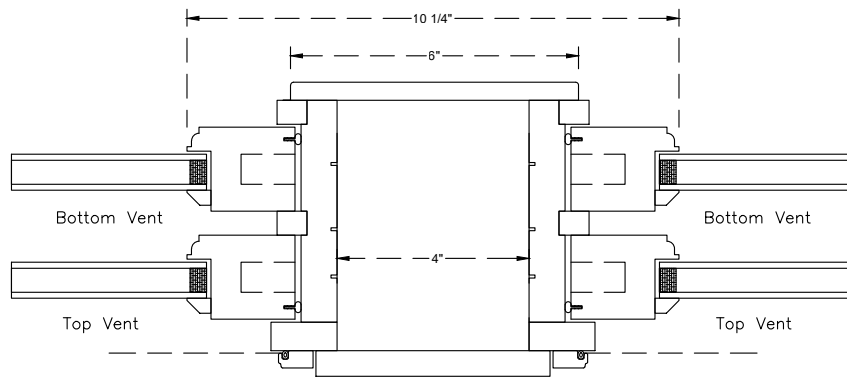

4" Space Mull

Double Hung, Hidden Balance

Section Details : Sill Options

SCALE: 3" = 1'-0"

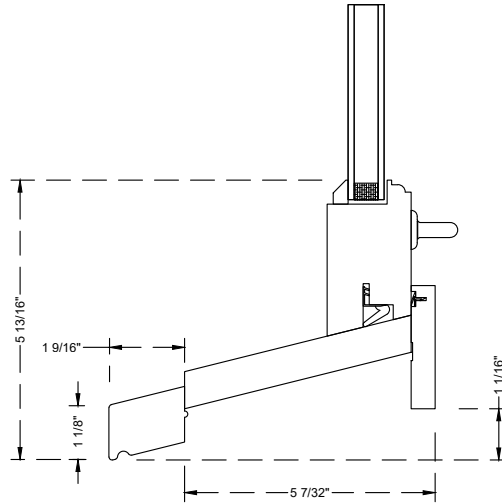

Standard Subsill (2814)

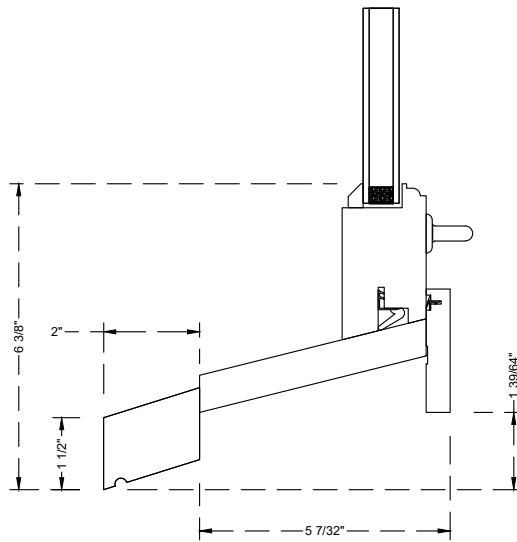

True Subsill Match (2816)

Double Hung, Block & Tackle

Section Details : Exterior Trim Options

SCALE: 3" = 1'-0"

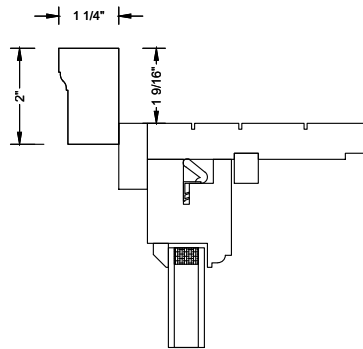

Brickmold Casing

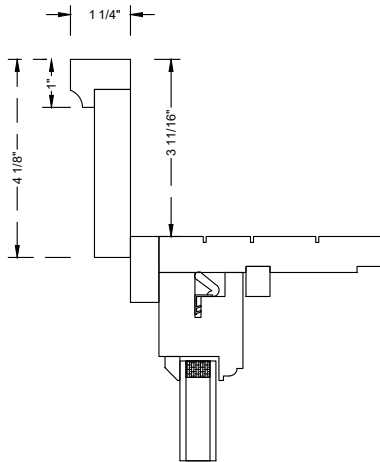

1 x 4 Casing w/ Backband

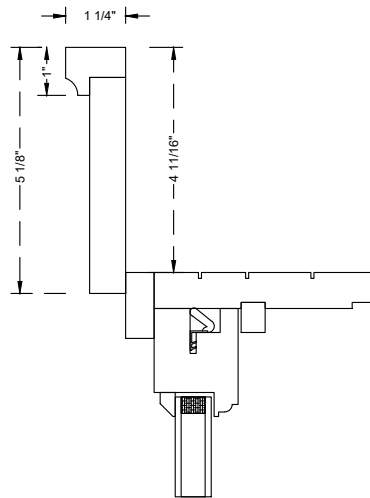

1 x 5 Casing w/ Backband

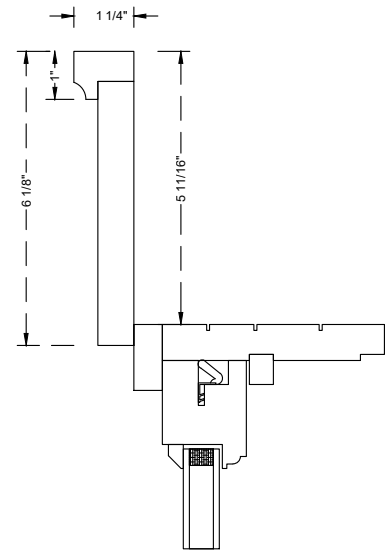

1 x 6 Casing w/ Backband

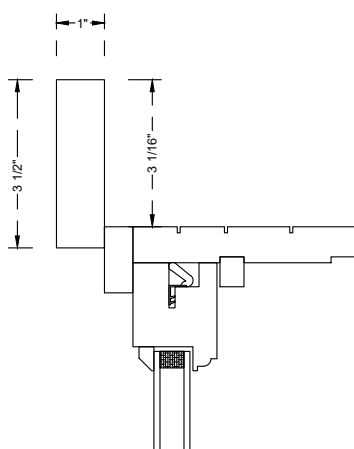

5/4 x 4 Casing

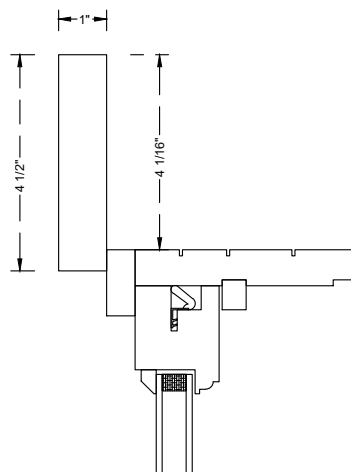

5/4 x 5 Casing

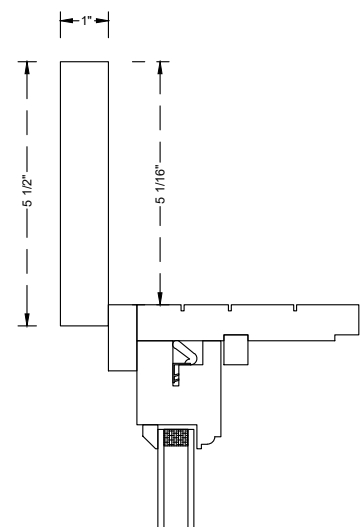

5/4 x 6 Casing

Double Hung, Block & Tackle



Section Details : Nail Fin Options

SCALE: 3" = 1'-0"

Flush Fin

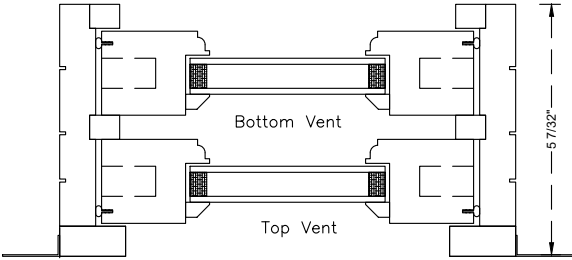
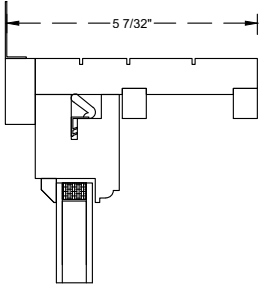

1 5/16 Setback Nail Fin*
*Not compatible with brickmold or subsills

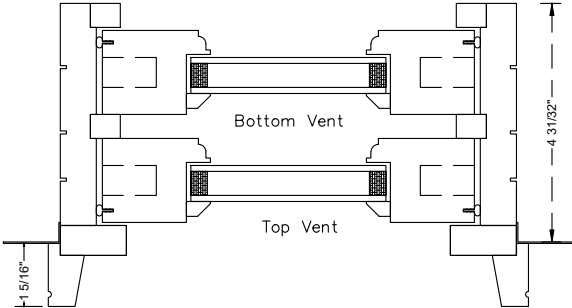
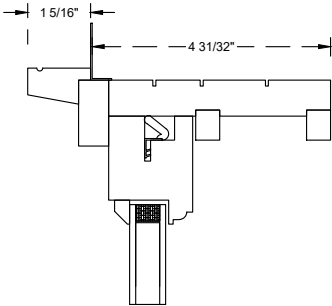

Nailfin applied to head and sides only